

SPIRAL CABLE WITH CONNECTORS

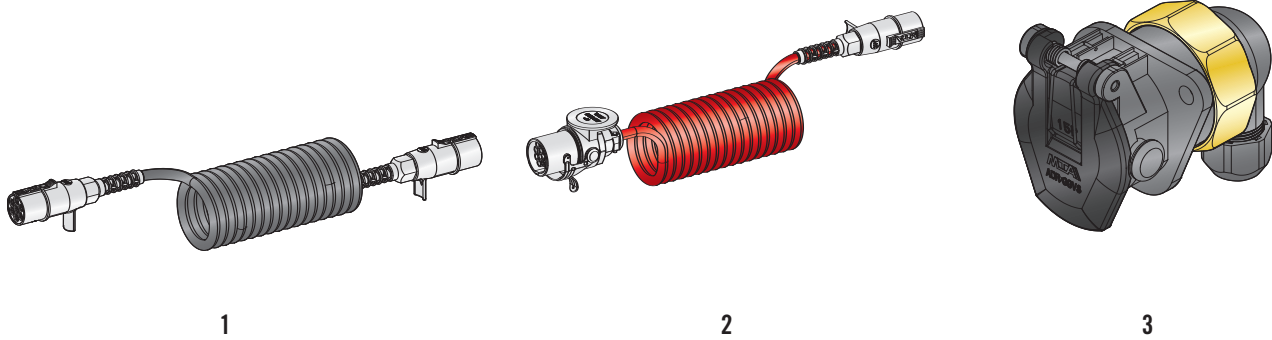

IMG	DESCRIPTION	PIN N.	SPIRAL COLOUR	MAX LENGTH mm	P/N	M.O.Q.
1	SPIRAL CABLE VOLKSWAGEN	7	■ Black	4200	9815530	10
	SPIRAL CABLE FORD	7	■ Red	5500	9815540	10
2	SPIRAL CABLE FORD	15-7	■ Red	5500	9815550	10
3	SOCKET FOR SPIRAL CABLE	15	-	-	2550087	50

RELAYS

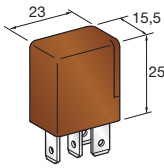

1

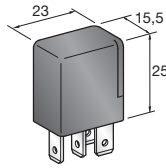

2

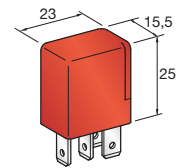

3

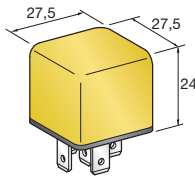

4

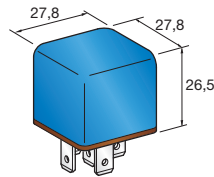

5

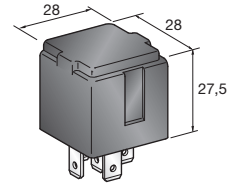

6

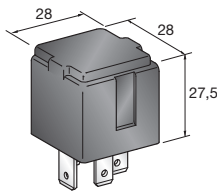

7

IMG	DESCRIPTION	COLOUR	RATED CURRENT WITH 80° C	RATED VOLTAGE	WORKING TEMPERATURE T.min/T.max	P/N BOX	M.O.Q.
1	MICRO RELAY	■ Brown	10A (NC) - 20A (NO)	12 V	-40°C +125°C	0603000	1
2	MICRO RELAY	■ Black	20A (NO)	12 V	-40°C +125°C	0603010	1
3	MICRO RELAY	■ Red	30A (NO)	12 V	-40°C +125°C	0603020	1
4	MINI RELAY	■ Yellow	30A (NO)	12 V	-30°C +80°C	0603030	1
5	MINI RELAY	■ Blue	30A (NO)	12 V	-40°C +125°C	0603040	1
6	MINI RELAY	■ Black	15A (NC) - 30A (NO)	12 V	-30°C +100°C	0603060	1
7	MAXI RELAY	■ Black	50A (NO)	12 V	-40°C +125°C	0603050	1

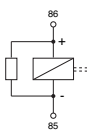

1

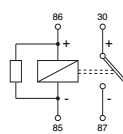

2

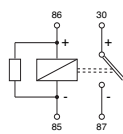

3

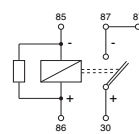

4

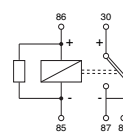

5

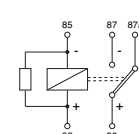

6

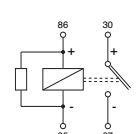

7

SELF EXTINGUISHING INSULATING TAPE

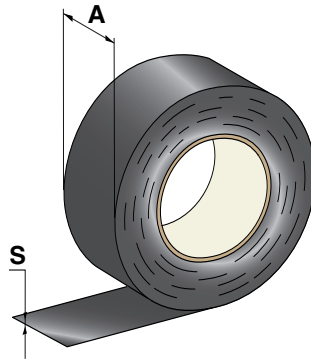

1

IMG	DESCRIPTION	MATERIAL	COLOUR	A mm	L mm	S mm	P/N BOX	M.O.Q.
1	SELF-EXTINGUISHING INSULATING TAPE	PVC - V0	■ Black	15	10000	0,15	4640100	10
	SELF-EXTINGUISHING INSULATING TAPE	PVC - V0	■ Red	15	10000	0,15	4640110	10
	SELF-EXTINGUISHING INSULATING TAPE	PVC - V0	■ Black	15	25000	0,15	4640200	10
	SELF-EXTINGUISHING INSULATING TAPE	PVC - V0	■ Black	19	25000	0,15	4640300	10
	SELF-EXTINGUISHING INSULATING CLOTH TAPE	RAYON	■ Black	19	25000	0,28	0100302	96

CAR RADIO WIRES

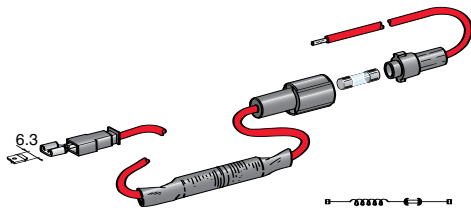

1

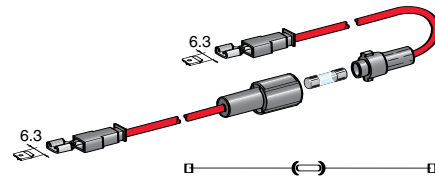

2

IMG	DESCRIPTION	INDUCTANCE	CABLE	L mm		P/N BOX	M.O.Q.
1	INDUCTIVE CAPACITIVE FILTER	15 ? H	-	500		3308517	10
2	CAR RADIO FEEDING WIRE	-	0,8	500		2608241	10

LAMP HOLDERS

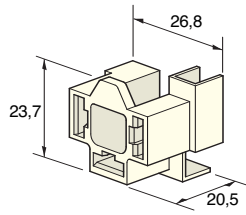

1

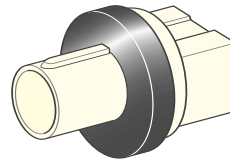

2

IMG	DESCRIPTION	MATERIAL	P/N BOX	M.O.Q.
1	3WAY LAMP HOLDER	PA	4410510	50
2	PARKING LIGHTS AND DASHBOARD FOR LAMPS WITH W 2.1 X 9.5 D SOCKET		4008500	50

CONNECTIONS AND FIXINGS



IMG	1
-----	---

EARTH CONNECTIONS

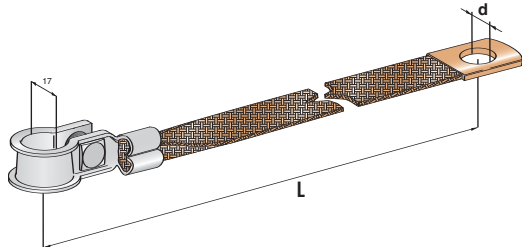

1

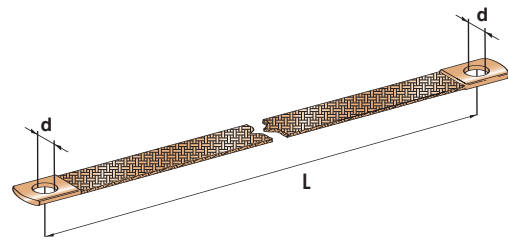

2

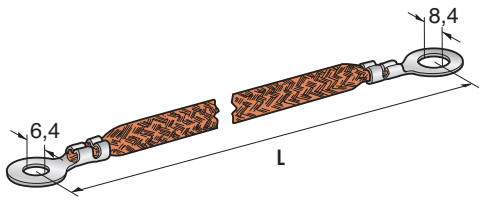

3

IMG	DESCRIPTION	SECTION mm ²	d mm	L mm		P/N BOX	M.O.Q.
1	EARTH CONNECTION	25	12,5	300		2508681	1
		25	12,5	400		2508682	1
		25	12,5	500		2508683	1
2	EARTH CONNECTION	10	8,4	210		2508650	1
		10	8,4	280		2508652	1
		15	10,4	330		2508660	1
		15	10,4	450		2508661	1
		15	10,4	280		2508662	1
		15	10,4	210		2508663	1
		25	12,5	320		2507670	1
		25	12,5	230		2508671	1
3	EARTH CONNECTION	25	12,5	400		2508672	1
		-	-	300		2508220	10



1

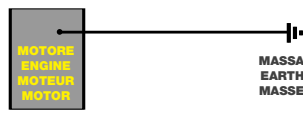

2

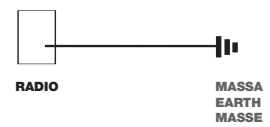

3